

BYRNE

Dean® Z-Mount



* Image depicts a 3 window unit with 2 power and 1 USB with a Black faceplate and Matte Black mounting bracket

OVERVIEW

Sleek and understated, Dean Z's low profile and smooth, easy-to-clean surface doesn't pull attention away from other workplace elements. Dean's powder-coated trim and coordinating faceplate is also offered in a range of fresh neutrals, for just the right amount of design impact.

SPECIFICATIONS

* Images depict a 3 Window unit with 2 Power, and 1 USB

Cut out dimensions vary based on product length

2 Window	4-3/4"	x	1-15/16"
3 Window	6-1/4"	x	1-15/16"
4 Window	7-3/4"	x	1-15/16"
5 Window	9-1/4"	x	1-15/16"

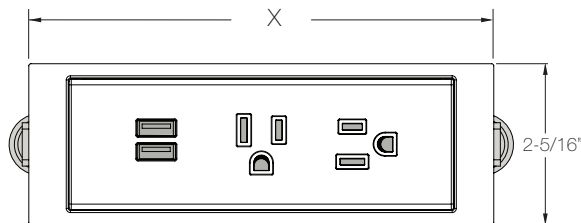

Min - Max Surface Depth

3/4" - 1-1/2"

X and Y dimensions:

Unit Size	X Length	Y Length
2 Window	5-3/16"	4-3/4"
3 Window	6-11/16"	6-1/4"
4 Window	8-3/16"	7-3/4"
5 Window	9-11/16"	9-1/4"

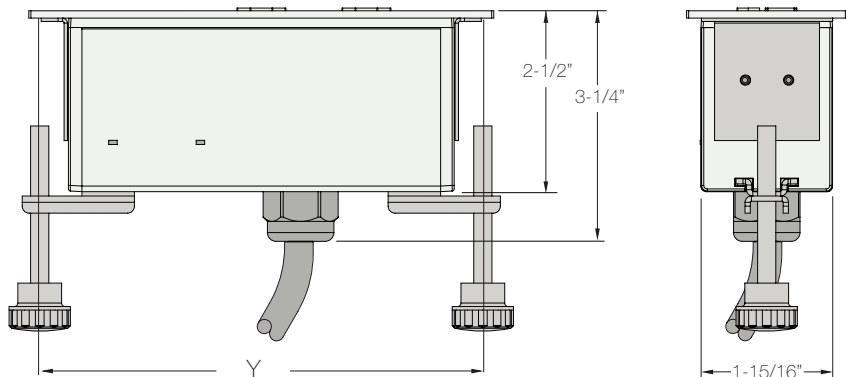

CONFIGURATIONS AVAILABLE

Available in 2, 3, 4, and 5 window units with 15 Amp power simplexes, Tamper Resistant simplexes (upon request), and dual port USB options (2 Amp per port). Below is a graphic representation of the power and data configurations available for this unit.

2 Windows



2 Power



1 USB, 1 Power

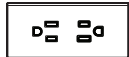

2 Power (Rotated)

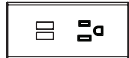

1 USB, 1 Power (Rotated)

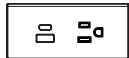

1 USB-A+C, 1 Power

3 Windows



3 Power (Rotated)



1 USB, 2 Power (Rotated)



1 USB-C 60W, 1 Power

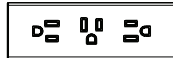

3 Power (Rotated)

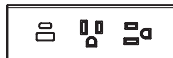

1 USB-A+C, 2 Power

4 Windows



4 Power (Rotated)



1 USB, 3 Power (Rotated)

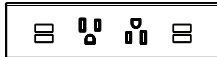

2 USB, 2 Power

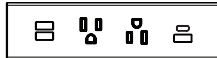

1 USB, 2 Power, 1 USB-A+C

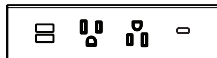

1 USB, 2 Power, 1 USB-C 18W



1 USB-C 60W, 2 Power

5 Windows



5 Power



2 USB-A+C, 3 Power



2 USB, 3 Power



1 USB-C 60W, 3 Power

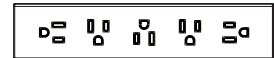

5 Power (Rotated)



1 USB-C 60W, 1 USB, 2 Power



2 USB, 3 Power (Rotated)

Data Options



Cat6, Cat6 A, HDMI, VGA, Mini DisplayPort, Stereo Jack, Passive USB-A, and Passive USB-C

NOTE: Factory install only for Mini DisplayPort

Available with Tamper Resistant Simplexes

Tamper Resistant units will be labeled with TR in the left hand corner of the faceplate.

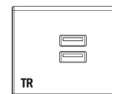

POWER ENTRY OPTIONS

UL LISTED

Corded
Hardwired
4-Trac interconnect
8-Trac interconnect

UL RECOGNIZED

Interlink
Interlink IQ 2.0

ETL LISTED

Interlink
Interlink IQ 2.0

NEW YORK

The Corded Dean can be used in the New York City, per the official NYC Electrical Code.

CHICAGO

The Corded Dean Z can be used on Listed freestanding furnishings in Chicago. Limitations apply. The Hardwired Dean Z must be used on all other furnishings in Chicago



FINISHES

Dean's housing is clear anodized aluminum. The faceplate is molded plastic and the trim is powder coated steel. The color of the cord will default to white unless the faceplate is black, in which case it will default to a black cord. Braided cords are also available upon request.

Faceplate

- | | | |
|---|---|---|
|  Black
Molded Plastic |  Poppy
Molded Plastic |  Peacock
Molded Plastic |
|  White
Molded Plastic |  Storm
Molded Plastic |  Fog
Molded Plastic |
|  Honey
Molded Plastic |  Dusk
Molded Plastic | |
|  Navy
Molded Plastic |  Berry
Molded Plastic | |



Trim

- | |
|--|
|  Black
Powder Coated Metal |
|  White
Powder Coated Metal |
|  Storm
Powder Coated Metal |
|  Fog
Powder Coated Metal |

FINISH AREAS



Colors represent areas of different material used on the product.

- | | |
|---|--------------------------|
|  | Powder Coated Steel Trim |
|  | Molded Plastic |