

BYRNE

INSTALLATION INSTRUCTIONS FOR GLENBEIGH®

Install data jacks as described in the installation instructions provided with data adapters, BE01421

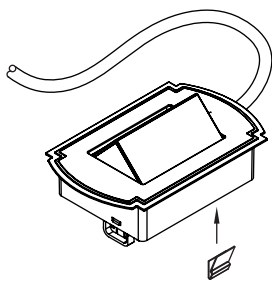
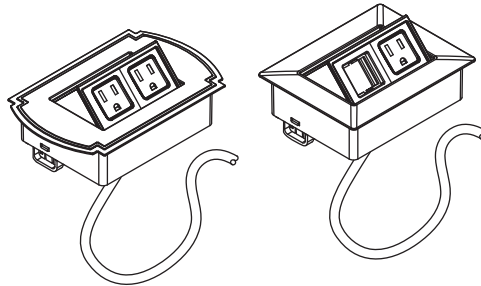
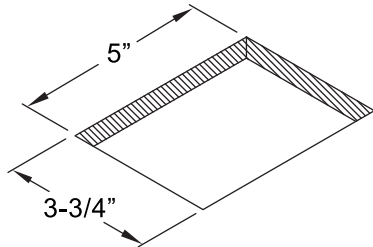

1

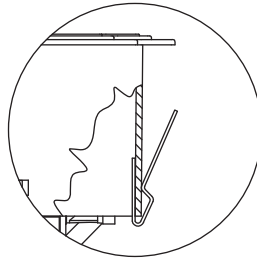

Attach 1 clips, at back of unit base.

Note: Metal clips are for use in hard surface material only as an optional mounting means

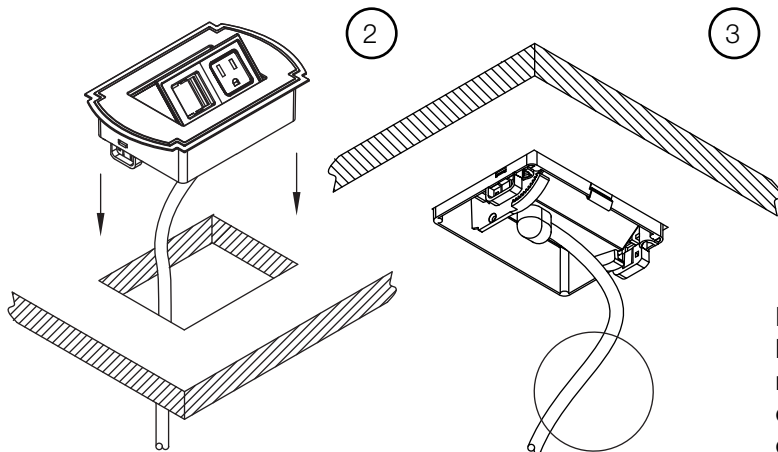

2

3

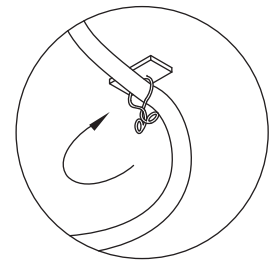
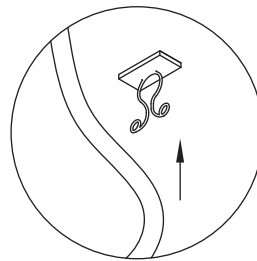

Note: In a conduit application, conduit should be supported according to local code. When managing conduit and cabling exiting the unit, ensure there is adequate slack to allow unit to open properly

4

