

# BYRNE

## Ellora® Qi

Wireless Charging

blended.byrne.com



### OVERVIEW

A seamless, one piece aluminum grommet that keeps cables out of sight, by allowing use while the lid is shut. The lid is equipped with three (10 Watt) Qi charging coils, capable of charging up to 3 smart phones at a time. Ellora Qi is offered in a 6 window unit only, with 4 windows available for 15 Amp power and charging USB. The lid comes with LED lights that change colors to indicate when a device is paired to one of the wireless receivers. Ellora Qi is Qi-certified.

### SPECIFICATIONS

\* Images depict a 6 Window Ellora Qi with 3 Power and 1 USB

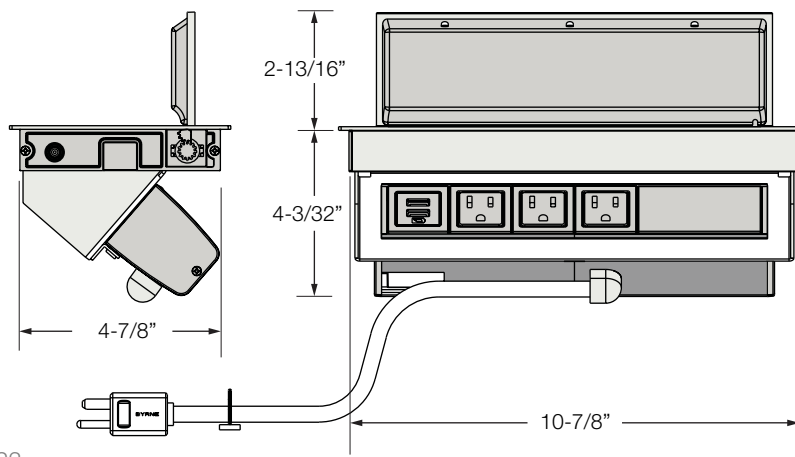
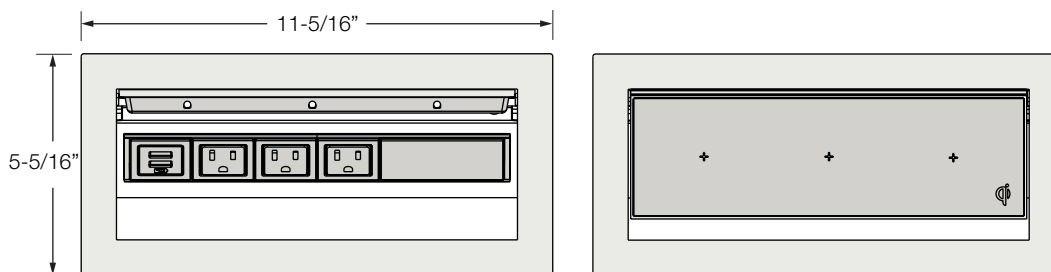

#### Cut Out Sizes

10-7/8" x 4-7/8"

#### Min Surface Depth

3/8"

#### Max Surface Depth

1 1/2"

### POWER ENTRY OPTIONS & CODES

#### UL LISTED

Corded  
Hardwire

#### UL RECOGNIZED & ETL LISTED

Interlink  
Interlink IQ 2.0

#### NEW YORK

The Corded Ellora Qi can be used in New York City as per the New York City Electrical Code.

#### CHICAGO

The Corded Ellora Qi can be used on Listed freestanding furnishings in Chicago. Limitations apply. The Hardwired Ellora Qi must be used on all other furnishings in Chicago

## CONFIGURATION

Elora Qi's configuration has three (10 Watt) Qi charging coils built into the soft-closing lid of the product. Inside, there are 6 windows, 2 of which are taken up for the Qi power supply. The other 4 windows can be replaced by a variety of power or technology options.

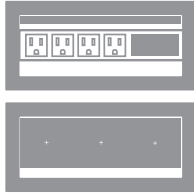

## INTEGRATED TECHNOLOGIES

The power simplexes must be grouped together and installed at the **right end** of this product. Technologies requiring power must immediately follow.

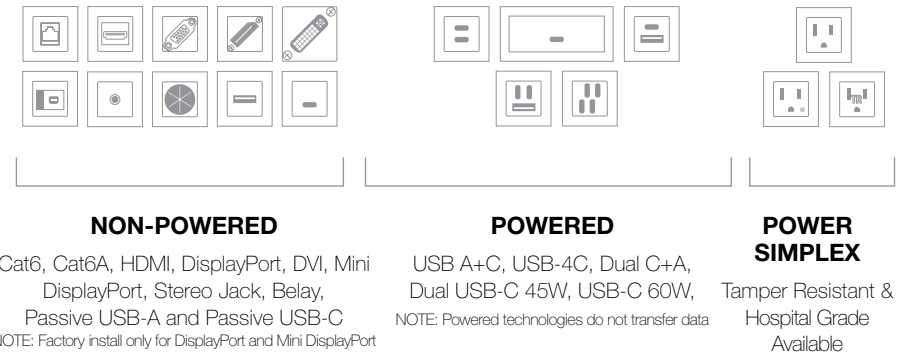

## FINISHES

One piece aluminum grommet offered in 4 powder coated colors: Matte Black, Matte White, Matte Storm, and Matt Fog. The lid inserts and simplexes are molded plastic and come in the same 4 colors.

### ANODIZED ALUMINUM HOUSING AND GROMMET

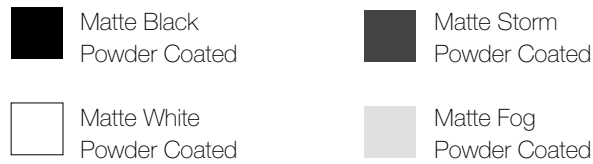

### INSIDE FACEPLATE

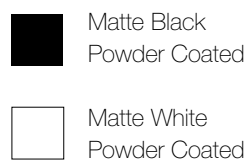

### PLASTIC SIMPLEXES, WINDOW FRAMES AND END CAPS

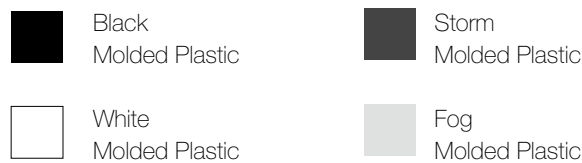

## FINISH AREAS

