

BYRNE

Assemble®



* image shown: 4 Window Assemble with 1 USB A+C, Dual Charging USB, with 2 Power.

OVERVIEW

Assemble brings new flexibility to the surface, because it doesn't require any cutout or installation. This hardworking power and data center easily attaches to the edge, accommodating tables and desktops of varying thickness.

SPECIFICATIONS

* Images depicts a 3 power, and 2 open data windows.

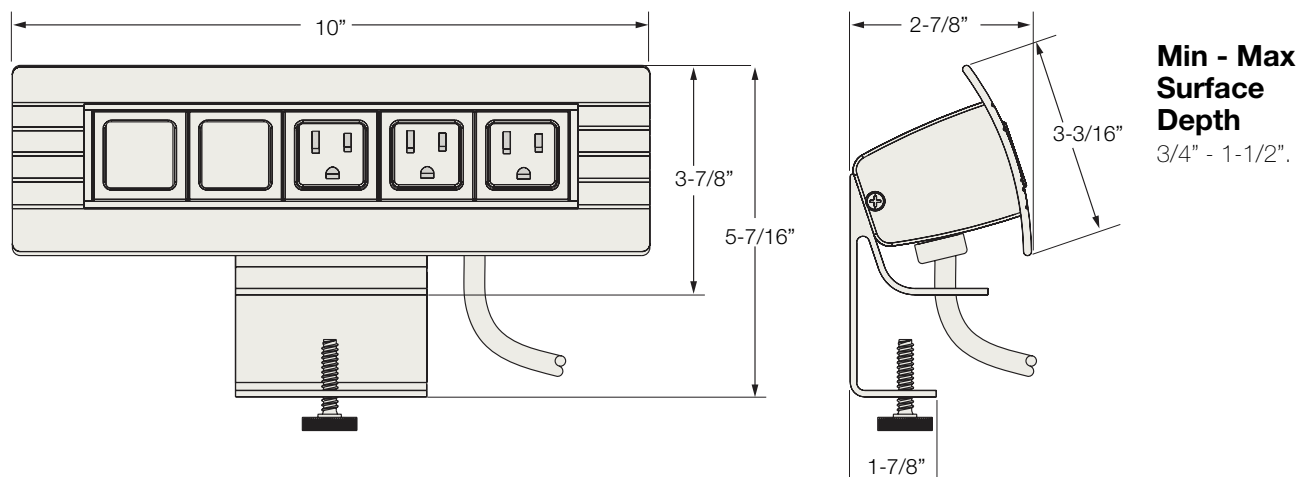

CUSTOMIZE BY SIZE

Assemble offers from 2 to 8 windows, as shown below. Each window can be replaced by a variety of power or technology options.

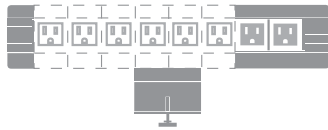

POWER INFEED OPTIONS

UL LISTED

Corded
4-Trac*
8-Trac*
Hardwire

UL RECOGNIZED & ETL LISTED

Interlink
Interlink IQ 2.0

CODES

NEW YORK

The Corded Assemble can be used in the New York City, as per the NYC Electrical Code.

CHICAGO

The Corded Assemble can be used on Listed freestanding furnishings in Chicago. Limitations apply. The Hardwired Assemble must be used on all other furnishings in Chicago

INTEGRATED TECHNOLOGIES

The power simplexes must be grouped together and installed at the **right end** of this product. Technologies requiring power must immediately follow.

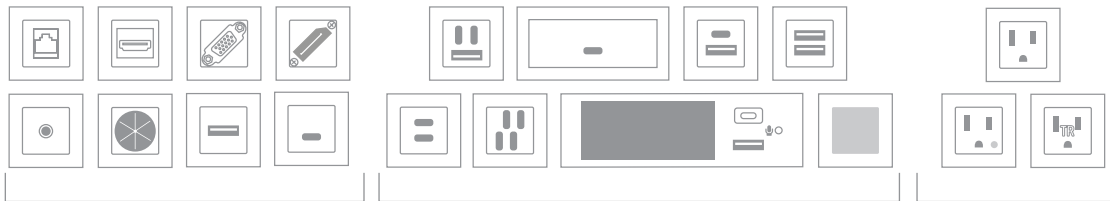

NON-POWERED

Cat6, Cat6A, HDMI, VGA, DisplayPort, DVI, Mini DisplayPort, Stereo Jack, Belay, Passive USB-A, and Passive USB-C

NOTE: Factory install only for DisplayPort and Mini DisplayPort

POWERED

USB-4C, Dual C+A, Dual USB-C 45W, USB-C 60W, USB A+C, Dual USB, Embrava®, Retractable Charging Cord, Bluetooth® Speaker



NOTE: Powered Technologies do not transfer data

POWER SIMPLEX

Tamper Resistant & Hospital Grade Available

FINISHES



ANODIZED ALUMINUM HOUSING & FACEPLATE

-  Black Anodized Aluminum
-  Clear Anodized Aluminum

PLASTIC END CAPS & WINDOW FRAMES

-  White
-  Black
-  Grey

SIMPLEX

-  Black
-  White

FINISH AREAS

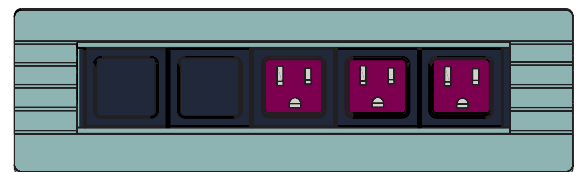

-  Anodized Aluminum Housing & Faceplate
-  End Caps & Window Frames
-  Simplex