

BYRNE

Dot[®] Z



* image shown: 3 Window Dot unit with 3 Power, with Clear Anodized Aluminum Faceplate and Housing, and Navy Plastic.

OVERVIEW

Dot Z offers a combination of Power and charging USB in a new, sleek flush mount package. With Byrne's patented spill-proof outlets, Dot's flush mount design delivers a UL Listed solution in any work surface. Currently available in 2 and 3 window units.

SPECIFICATIONS

* Images depicts a 2 Power, and 1 USB Dot unit.

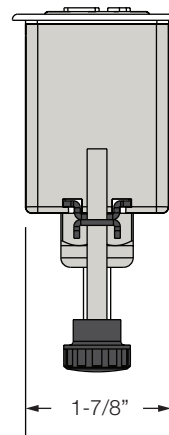
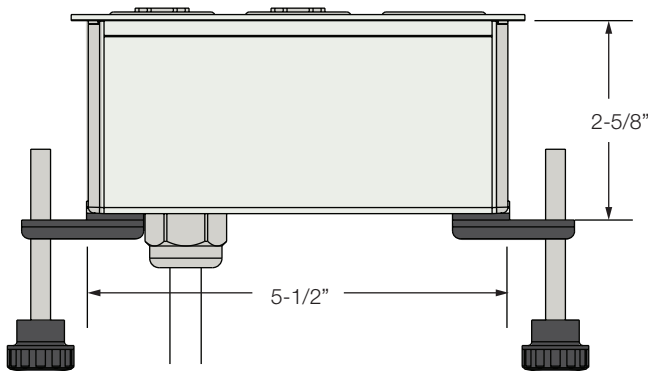
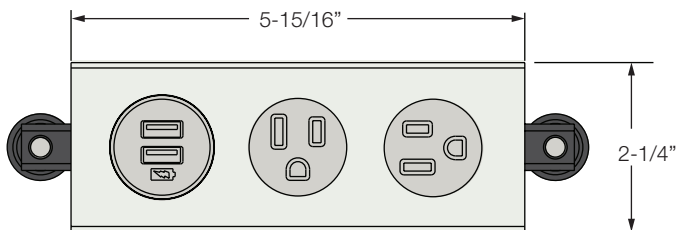

**Min - Max
Surface Depth**
3/4" - 1-1/2".

Cut Out Sizes

2 Window Dot
2" by 3-7/8"

3 Window Dot
2" by 5-5/8"

CONFIGURATIONS AVAILABLE

Dot Z is available with 2 or 3 windows. Currently we offer dual USB-A, USB A+C, and 15 Amp power simplexes with this product. Below is a graphic representation of the power and technology configurations available for this unit.

2 Window Unit

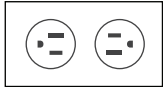

2 Power

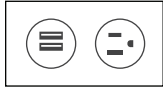

1 USB and 1 Power

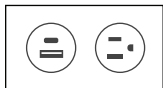

1 USB-A+C and 1 Power

3 Window Unit

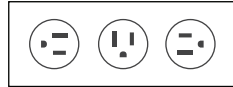

3 Power



1 USB and 2 Power

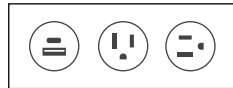

1 USB-A+C and 2 Power



FINISHES

Dot's housing comes standard in clear anodized aluminum. The color of the cord will default to white unless the simplex and end caps are black, in which case it will default to a black cord.

Simplex

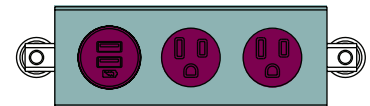

 Black Molded Plastic	 Poppy Molded Plastic
 White Molded Plastic	 Storm Molded Plastic
 Honey Molded Plastic	 Dusk Molded Plastic
 Navy Molded Plastic	 Berry Molded Plastic
 Fog Molded Plastic	 Peacock Molded Plastic



 Anodized Aluminum Housing
 Simplex

Colors above represent different material areas that change depending on the finish chosen.

Housing

 Black Anodized Aluminum	 Clear Anodized Aluminum
---	---

POWER ENTRY OPTIONS & CODES

UL LISTED

Corded

ETL LISTED

4-Trac
8-Trac
Hardwire

NEW YORK The Corded Dot Z can be used in New York City, as per the NYC Electrical Code.

CHICAGO

The Corded Dot Z can be used on Listed freestanding furnishings in Chicago. Limitations apply. The Hardwired Dot must be used on all other furnishings in Chicago.